



**POWER SOLUTIONS
INTERNATIONAL**

53L OPERATIONS & MAINTENANCE MANUAL

Large Spark Ignited

This publication may not be reproduced without written permission of Power Solutions International (PSI). At date of publication, all information included in this manual is accurate to the best of our knowledge. PSI cannot be held responsible for information that has changed after publication date.

**Power Solutions International, Inc (PSI)
201 Mittel Drive Wood Dale, IL 60191 USA
630-350-9400**

REVISION CONTROL INFORMATION

Revision Level	Release Date	Change Description (s)
1	04/03/2020	Initial Release
2	01/20/2020	
3	02/10/2022	Updated PM Schedules
4	06/20/2022	
5	01/24/2023	Added identification images. Added speed sensor install procedure
6	02/16/2023	Added revision control sheet. Added additional information to clarify coolant specification & engine oil specification.
7	04/05/2023	Spark plug interval for LTP/Prime changed to 750 hours, Throttle Body PM interval updated to 4,000 for LTP and Prime applications
8	08/23/2023	Update to engine break in procedure language, relocated Pre-Lube section towards front of manual with Break-In procedure
9	6/25/2024	Updated Oil Filter tightening spec
10	7/18/2024	Corrected typo in valve clearance spec.

Table of Contents

Introduction	6
How to Use This Manual	6
Engine Identification	6
Parts and Service.....	7
Service Literature	7
Certified Engine Emissions Information	8
US EPA EMISSION CONTROL WARRANTY STATEMENTYOUR WARRANTY RIGHTS AND OBLIGATIONS	8
MANUFACTURER’S WARRANTY COVERAGE	9
OWNER’S WARRANTY RESPONSIBILITIES	9
DEFECTS WARRANTY REQUIREMENTS:	10
DEFECTS WARRANTY REQUIREMENTS:	11
Operating Instructions	12
Schematic Diagrams of 53L Natural Gas Engine.....	12
Engine Orientation	16
Fuel Systems	16
Governors	17
Oil Pressure	17
Coolant Temperature	17
Voltage Reading	17
Tachometer/Hourmeter	17
Engine Pre-Lube Break In Requirements	18
Pre-Lube Assembly	19
Maintenance Instructions	19
Starting the Engine	20
Natural Gas Fuel Systems	20
Stopping the Engine	20
Fuel Recommendations Fuel Quality	20
Spark Plugs	20
Power Loss at Higher Elevations & Temperatures	20
Maintenance Instructions	21
Initial Start Up Maintenance	21
Routine Maintenance	21
Engine Oil	21
Low-Load Engine Operations	22

Engine Coolant	22
Engine Maintenance Guidelines - Standby Maintenance Table	23
Engine Maintenance Guidelines — Prime	25
Engine Maintenance Guidelines — Limited Time Power	27
The service life of an engine is influenced by several factors including correct installation, operating at proper rated load, proper service and inspection by trained technicians, and the use of approved engine oil, filters, and coolant.....	28
Engine Maintenance Guideline-Standby	29
Do not overfill	29
Drain LPL vaporizer oil buildup (if LP fuel system is being used):	39
Inspect ignition coils, coil boots, and harnesses:	39
Replace spark plugs:	39
Drain, flush, and replace engine coolant:	40
Draining the Cooling System:	40
Flushing the Cooling System:	40
Refilling the Cooling System:	41
Replace fan and alternator belts:	41
Replace ignition coils and boots:	43
Replace throttle bodies:	43
LONG-TERM STORAGE	45
Storing an engine over Six months:	45
Removing an engine from storage	46
APPENDIX: USING THE 4G SOFTWARE	47
Connecting to the Engine	47
Checking Faults	49

Introduction

Power Solutions International is pleased that you have selected our engine for your requirements. Power Solutions International takes great pride in our tradition of quality products produced from our line of industrial alternative fuel engines.

Certain checks should be made to the engine prior to startup. Please read the Initial Start-Up inspection requirements in the Maintenance Section of this manual. If you have further questions, please contact your PSI account representative or Customer Support Engineer.

How to Use This Manual

This manual contains instructions on the safe operation and preventive maintenance of your PSI engine. We urge you to read this manual prior to start up or operation of the engine.

PSI engines are built with a variety of standard and/or optional components to suit a broad range of customer requirements. This manual does not identify equipment as standard or optional. All the equipment described in this manual may not be found on your engine or power unit.

Please pay special attention to the NOTES, CAUTIONS, and WARNINGS. WARNINGS remind you to be careful in areas where carelessness can cause personal injury. CAUTIONS are given to prevent you from error that could cause damage to the equipment. NOTES give you added information designed to help you.

The descriptions and specifications contained in this manual were in effect at the time of publication. Power Solutions International reserves the right to discontinue models at any time, or to change specifications or design without notice and without incurring obligation.

Engine Identification

An identification label is affixed to the left side of the engine block when viewing it from the rear of the engine. The label (Figure 1) contains the engine model number, base engine part number, date of build, and PSI engine serial number. The PSI engine serial number is a unique number that identifies the engine from other PSI engines.



Figure 1

Engine Identification - continued

The engine model and serial number (see Figure 2) are required when seeking information concerning the engine and/or ordering replacement service parts.

The serial number is stamped in the valley of the block, near the rear of the engine on the right side.

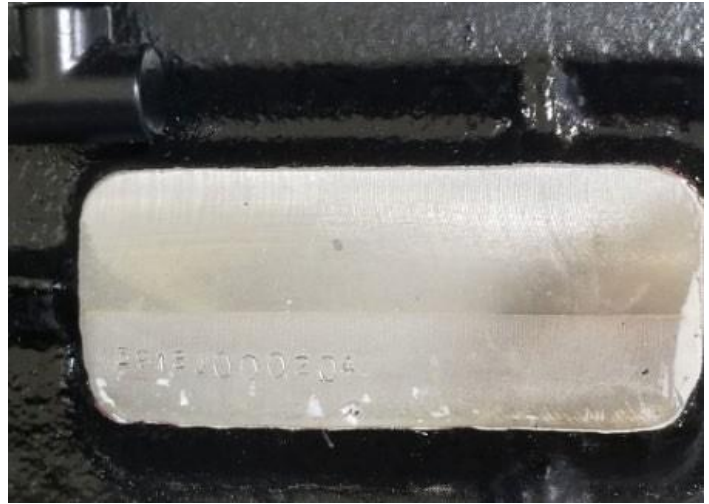

Figure 2

Parts and Service

Replacement parts can be obtained from Power Solutions International by calling the Aftermarket Parts Department at 888-331-5769 or parts@psiengines.com. The engine model and serial number will be required when seeking information and/or ordering parts.

Service and technical support for PSI engines can be obtained by contacting the Service Department at 888-331-5764 or via email at service@psiengines.com.

Service Literature

Additional operator manuals and service manuals for specific PSI engines can be obtained by contacting the Parts or Service Department at 888-331-5769 or via email at parts@psiengines.com

Certified Engine Emissions Information

The engine installed in your equipment is certified by POWER SOLUTIONS, INTERNATIONAL, INC. with the U.S. Environmental Protection Agency. The engine assembly is certified by PSI and is installed into your equipment by the equipment manufacturer following PSI's installation guidelines. The PSI certified engines have an emission label on or near the valve cover that identifies the engine emission family and the standards the engine is certified to. The label also provides some information regarding the maintenance of your engine.

The engine's emission control system does not require any adjustments, but the engine does require Preventative Maintenance (PM). Your obligation as the owner of the engine/equipment is to follow the engine's PM requirements outlined in this manual and to keep the engine in the proper working order. The equipment your engine is installed in will have a malfunction indicator lamp (MIL) for diagnosis of the engine's emission control system. If this lamp is illuminated, it is important to have the engine repaired. Failure to keep the engine in the proper state of repair can affect the performance of the engine's emission control system. Any unapproved modification to the engine's emission control system may potentially violate the engine's emission certification and may be subject to civil penalty.

The equipment manufacturer and/or equipment dealer will be your best resource regarding the proper support and information pertaining to the PSI certified engine and the equipment. Please contact the equipment manufacturer or equipment dealer first for questions and further information. You may contact PSI directly if you are unable to reach the equipment manufacturer or dealer. The PSI Service Department can be contacted at 888-331-5764.

Your PSI certified engine is covered by an Emission Control System Warranty Statement contained in this section. Your equipment and engine is warranted to you by the equipment manufacturer. In the event you are unable to receive a warranty from the equipment manufacturer or equipment dealer you can contact PSI directly for assistance with your PSI certified engine emission control system warranty. The PSI Warranty Department can be contacted at 888-331-5764.

US EPA EMISSION CONTROL WARRANTY STATEMENT YOUR WARRANTY RIGHTS AND OBLIGATIONS

The United States Environmental Protection Agency and Power Solutions International, Inc. are pleased to explain the emission control system warranty on your 2020 or later PSI heavy duty large spark-ignition (LSI) engine. New LSI engines must be designed, built and equipped to meet the US EPA's stringent emission standards. Power Solutions International, Inc. must warrant the emission control system on your LSI engine for the periods of time listed below provided there has been no abuse, neglect or improper maintenance of your LSI engine.

Your emission control system may include parts such as the carburetor, regulator or fuel-injection system, ignition system, engine computer unit (ECM), catalytic converter and air induction system. Also included may be sensors, hoses, belts, connectors and other emission-related assemblies.

Where a warrantable condition exists, Power Solutions International, Inc. will repair your LSI engine at no cost to you including diagnosis, parts and labor.

MANUFACTURER'S WARRANTY COVERAGE

The 2021 or later large spark-ignition engines are warranted for 8760 hours or three years, whichever occurs first (8760 hours or five years for high-cost warranty parts). If any emission related part on your engine is defective, the part will be repaired or replaced by Power Solutions International, Inc.

OWNER'S WARRANTY RESPONSIBILITIES

As the equipment and LSI engine owner, you are responsible for the performance of the required maintenance listed in your owner's manual. Power Solutions International, Inc. recommends that you retain all receipts covering maintenance on equipment and LSI engine, but Power Solutions International, Inc. cannot deny warranty solely for the lack of receipts or for your failure to ensure the performance of all scheduled maintenance.

As the equipment or LSI engine owner, you should however be aware that Power Solutions International, Inc. may deny you warranty coverage if equipment or LSI engine or a part has failed due to abuse, neglect, improper maintenance, or unapproved modifications.

Your engine is designed to operate on Natural Gas and/or LPG. Use of any other fuel may result in your engine no longer operating in compliance with the US EPA's emissions requirements.

You are responsible for presenting your equipment or LSI engine to a Power Solutions International, Inc. distribution center as soon as a problem exists. The warranty repairs should be completed by the dealer as expeditiously as possible.

If you have any questions regarding your warranty rights and responsibilities, you should contact Power Solutions International, Inc. via telephone at 1-800-551-2938 or contact Power Solutions International, Inc. in writing at:

Power Solutions International, Inc.

201 Mittel Dr.

Wood Dale, IL 60191 or

Fax: 888-331-5764

DEFECTS WARRANTY REQUIREMENTS:

- (a) The warranty period begins on the date the engine or equipment is delivered to an ultimate purchaser.
- (b) General Emissions Warranty Coverage. Power Solutions International, Inc. must warrant each LSI engine to the ultimate purchaser and each subsequent owner that the engine is:
 - (1) Designed, built, and equipped to conform with all applicable regulations adopted by the US EPA; and
 - (2) Free from defects in materials and workmanship that causes the failure of a warranted part for a period of 8760 hours or three years, whichever occurs first (8760 hours or five years for high-cost warranty parts).
- (c) The warranty on emissions-related parts will be interpreted as follows:
 - (1) Any warranted part that is not scheduled for replacement as required maintenance in the written instructions required by subsection (d) must be warranted for the warranty period defined in Subsection (b)(2). If any such part fails during the period of warranty coverage, it must be repaired or replaced by the manufacturer according to Subsection (4) below. Any such part repaired or replaced under the warranty must be warranted for the remaining warranty period.
 - (2) Any warranted part that is scheduled only for regular inspection in the written instructions required by subsection (d) must be warranted for the warranty period defined in Subsection (b)(2). A statement in such written instructions to the effect of "repair or replace as necessary" will not reduce the period of warranty coverage. Any such part repaired or replaced under warranty must be warranted for the remaining warranty period.
 - (3) Any warranted part that is scheduled for replacement as required maintenance in the written instructions required by subsection (d) must be warranted for the period of time prior to the first scheduled replacement point for that part. If the part fails prior to the first scheduled replacement, the part must be repaired or replaced by the engine manufacturer according to Subsection (4) below. Any such part repaired or replaced under warranty must be warranted for the remainder of the period prior to the first scheduled replacement point for the part.
 - (4) Repair or replacement of any warranted part under the warranty must be performed at no charge to the owner at a warranty station.
 - (5) Notwithstanding the provisions of Subsection (4) above, warranty services or repairs must be provided at all manufacturer distribution centers that are franchised to service the subject engines.
 - (6) The owner must not be charged for diagnostic labor that leads to the determination that a warranted part is in fact defective, provided that such diagnostic work is performed at a warranty station.
 - (7) The manufacturer is liable for damages to other engine components proximately caused by a failure under warranty of any warranted part.
 - (8) Throughout the emissions warranty period defined in Subsection (b)(2), the manufacturer must maintain a supply of warranted parts sufficient to meet the expected demand for such parts.
 - (9) Any replacement part may be used in the performance of any warranty maintenance or repairs and must be provided without charge to the owner. Such use will not reduce the warranty obligations of the manufacturer.
 - (10) Add-on or modified parts that are not exempted by the US EPA and may not be used. The use of any non-exempted add-on or modified parts will be grounds for disallowing a warranty claim. The manufacturer will not be liable to warrant failures of warranted parts caused using a non-exempted add-on or modified part.

DEFECTS WARRANTY REQUIREMENTS:

(d) Emission Warranty Parts List.

(1) Fuel Metering System

- (i) Air/fuel ratio feedback and control system.
- (ii) Carburetor system (internal parts and/or pressure regulator or fuel mixer or injection system).

(2) Air Induction System

- (i) Intake manifold(s) or air intake system. *
- (ii) Turbocharger systems. *
- (iii) Air filter

(3) Ignition Control System

- (i) Engine Wire Harness. *
- (ii) Ignition coil and spark plugs.

(4) Positive Crankcase Ventilation (PCV) System

- (i) PCV Valve/Breather.

(5) Catalyst System

- (i) Exhaust manifold. *
- (ii) Catalytic converter. *
- (iii) Engine Control Module (ECM). *
- (iv) Electronic Pressure Regulator (EPR).

(6) Miscellaneous items Used in Above Systems

- (i) Vacuum, temperature, and time sensitive valves and switches.
- (ii) Sensors used for electronic controls.
- (iii) Hoses, belts, connectors, assemblies, clamps, fittings, tubing, sealing gaskets or devices, and mounting hardware.
- (iv) Pulleys, belts, and idlers.

*Indicates high-cost warranty item

Operating Instructions

Schematic Diagrams of 53L Natural Gas Engine

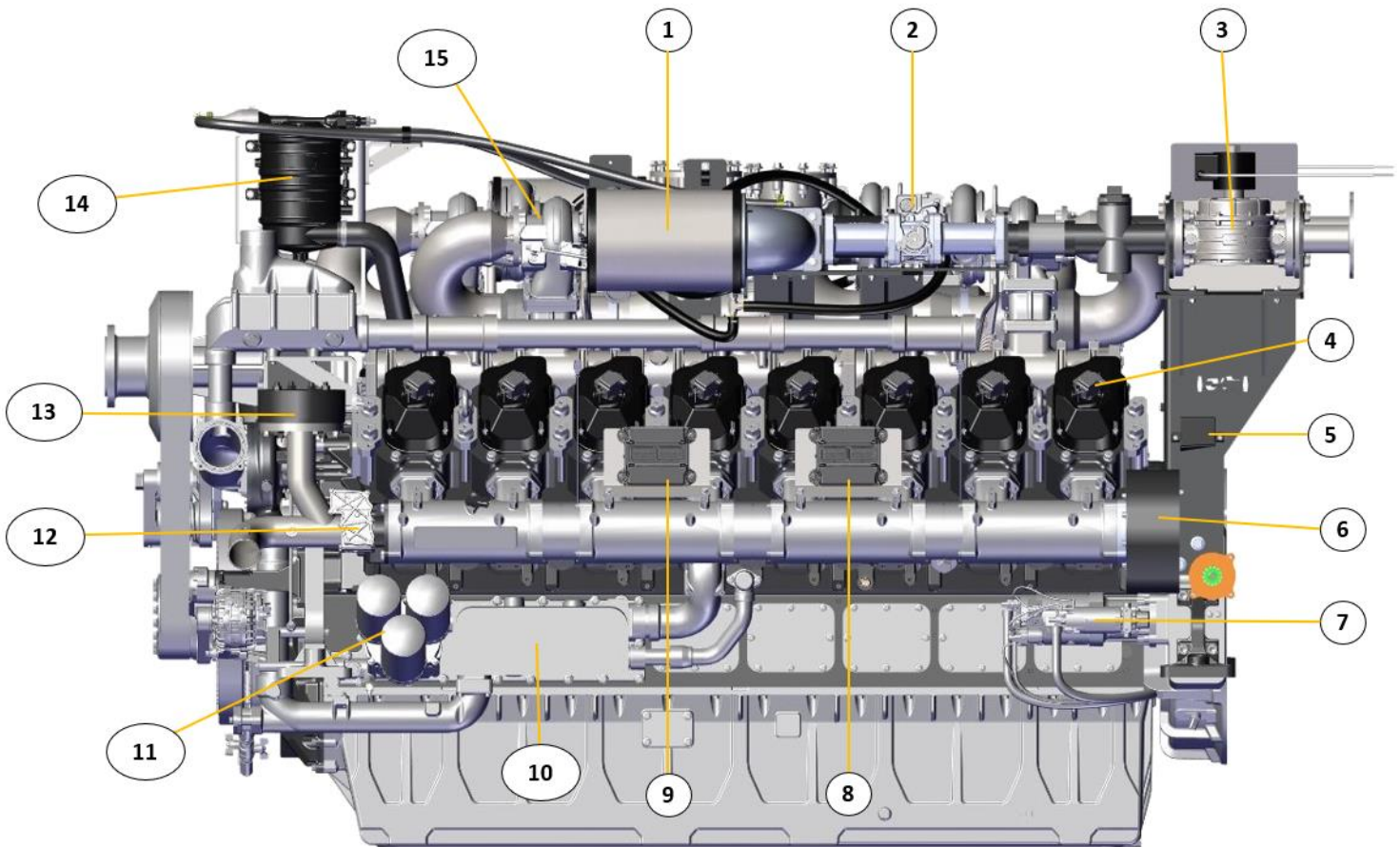

Figure 3 – Left Side View

- | | |
|----------------------------|-----------------------------|
| 1. Air Filter | 9. Primary ECM |
| 2. Mass Flow Gas Valve | 10. Oil Cooler |
| 3. Fuel Lock Off | 11. Oil Filters |
| 4. Ignition Coil | 12. Throttle Body |
| 5. Engine Harness Fuse Box | 13. Explosion Relief Valve |
| 6. Explosion Relief Valve | 14. CCV Canister |
| 7. Left Side Starter | 15. Turbocharger (Front LH) |
| 8. Secondary ECM | |

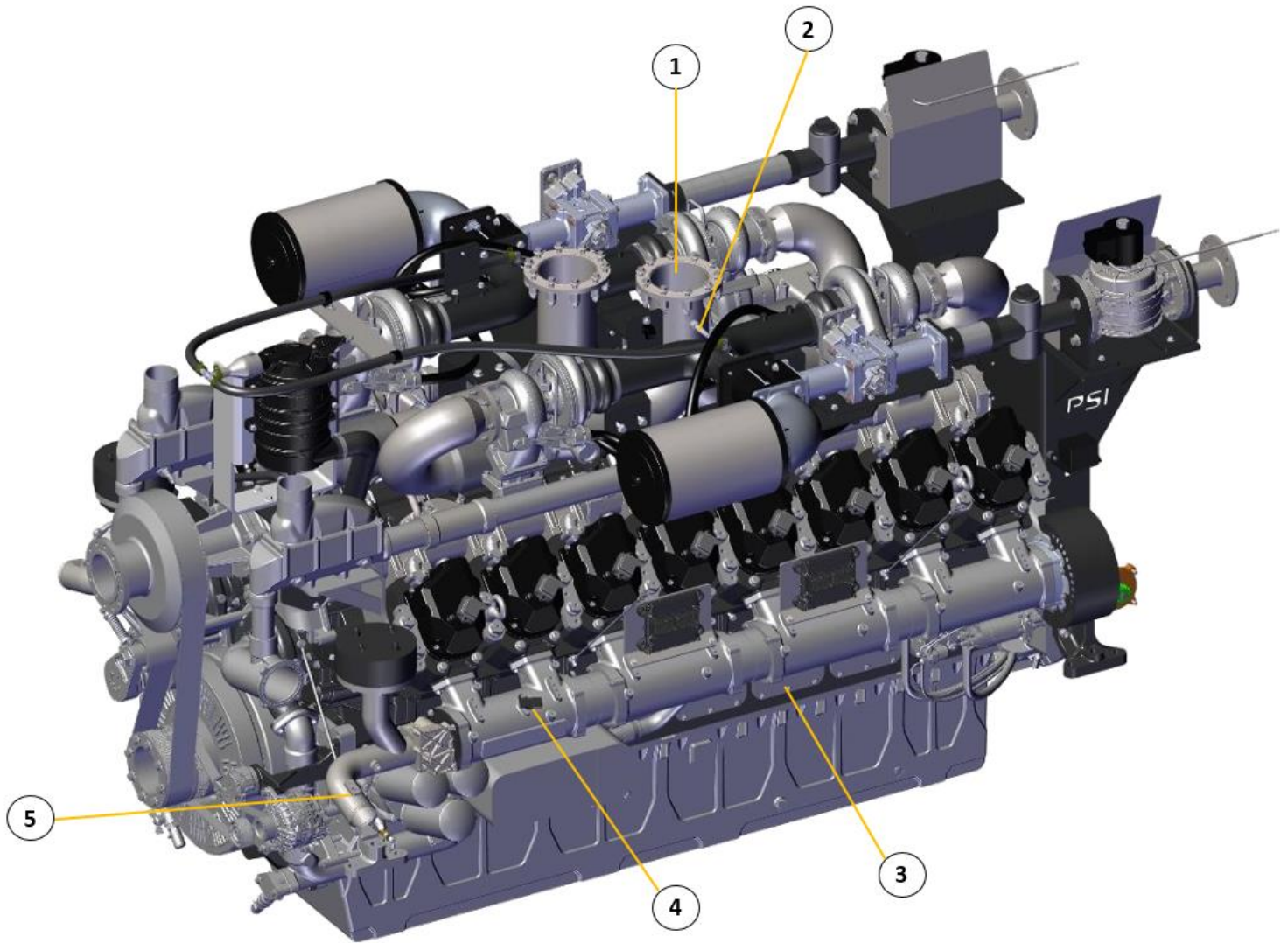

Figure 4 – Left View

- | | |
|--|---|
| 1. Exhaust Outlet to Catalyst | 4. TMAP Sensor |
| 2. Pre-Catalyst UEGO O2 Sensor (EGO 1) | 5. Throttle Inlet Pressure (TIP) Sensor |
| 3. Diagnostic Link Connector (DLC) | |

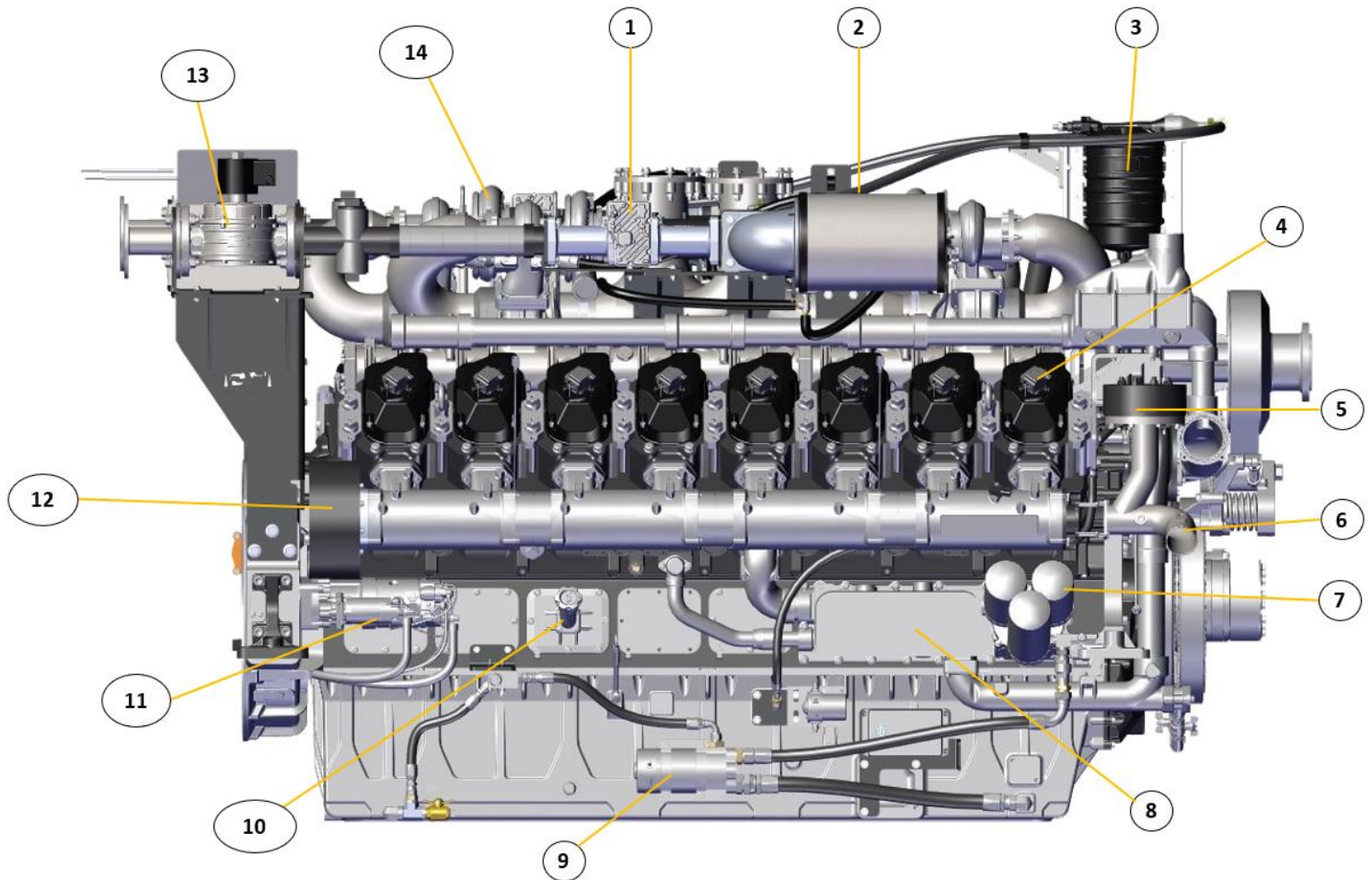

Figure 5 – Right Side View

- | | |
|----------------------------|----------------------------|
| 1. Mass Flow Gas Valve | 8. Oil Cooler |
| 2. Air Filter | 9. Oil Pre-Lube System |
| 3. CCV Canister | 10. Oil Fill Port |
| 4. Ignition Coil | 11. Starter (RH Side) |
| 5. Explosion Relief Valve | 12. Explosion Relief Valve |
| 6. Air/Fuel Inlet from CAC | 13. Fuel Lock Off Valve |
| 7. Oil Filters | 14. Turbocharger (Rear RH) |

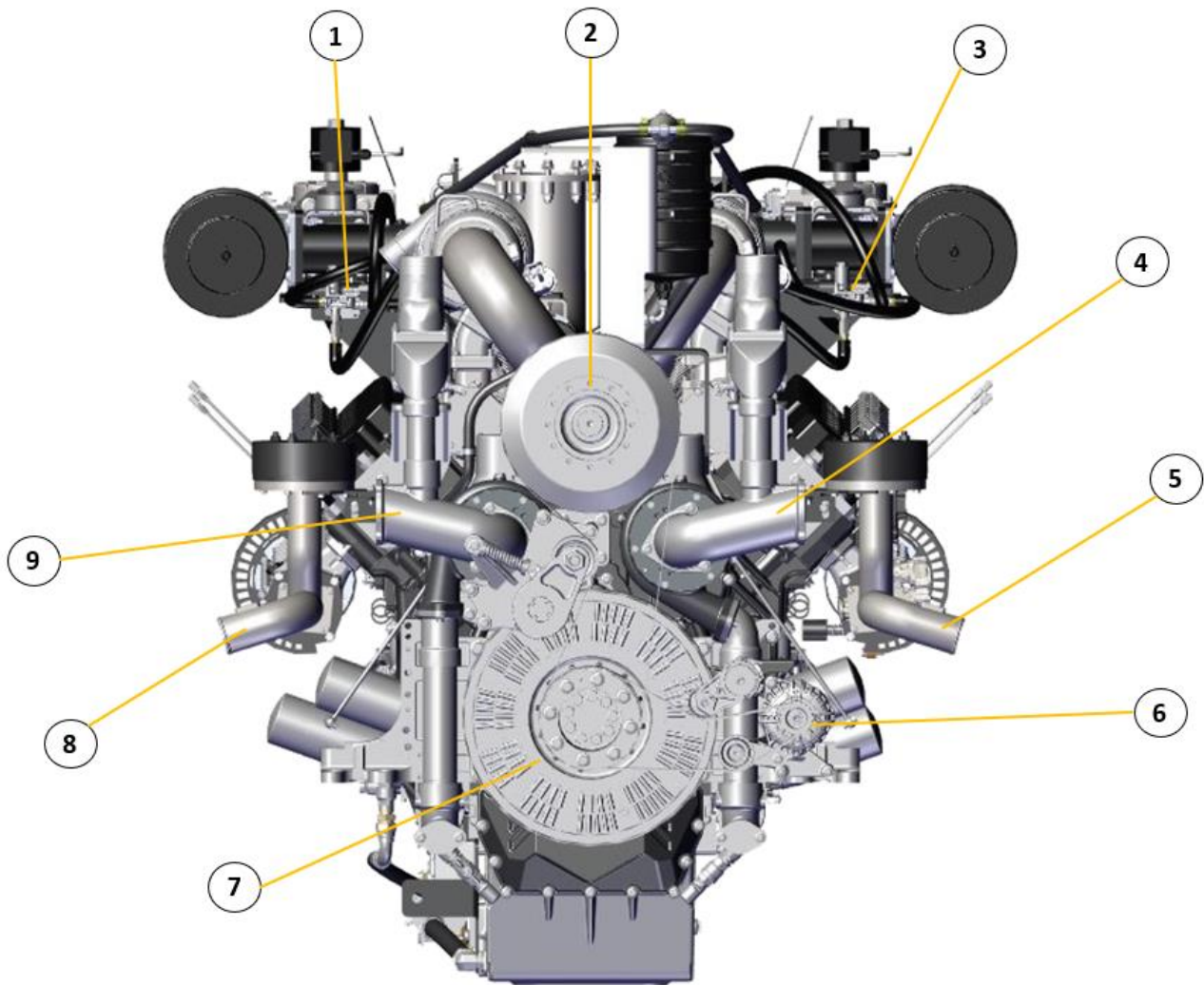

Figure 6 – Front View

- | | |
|---------------------------------|---|
| 1. Wastegate Control Valve | 6. Engine Alternator |
| 2. Fan Hub | 7. Harmonic Balancer (Vibration Dampener) |
| 3. Wastegate Control Valve | 8. Air/Fuel Inlet from CAC |
| 4. Coolant Outlet (to Radiator) | 9. Coolant Outlet (to Radiator) |
| 5. Air/Fuel Inlet from CAC | |

Engine Orientation

The PSI Energy 53L engine is a V16 engine. The front of the engine is the end with the crankshaft pulley and the rear of the engine is the end with the flywheel. Cylinder #1 is located on the left side of the engine closest to the flywheel as shown in figure 3. The control system uses two ECUs (engine control units) to operate the engine. The Master ECU controls all the components on the left side of the engine, and the slave ECU controls all components on the right side of the engine.

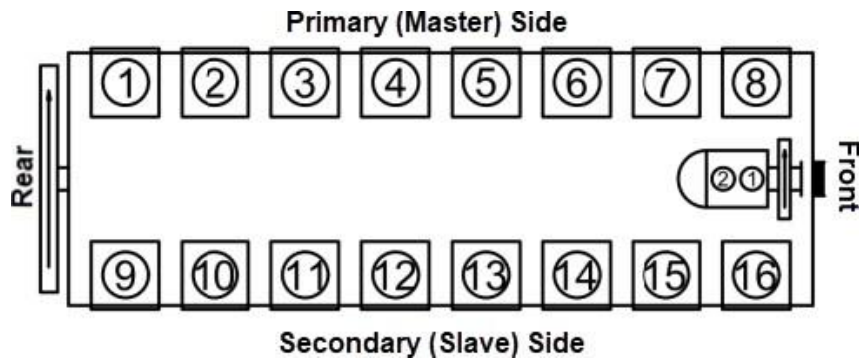

Figure 7

Fuel Systems

The fuel system installed on your engine operates with a Mass Flow Gas valve (MFG) one for each cylinder bank and a fuel nozzle as shown in figure 4. The MFG valves regulate the fuel flow being delivered to the fuel nozzle. These parts are not adjustable and should not be tampered with. Proper inlet fuel pressure is critical to the proper operation of the fuel system and engine; you should review the pressure, volume, and BTU recommendations prior to commissioning the engine.

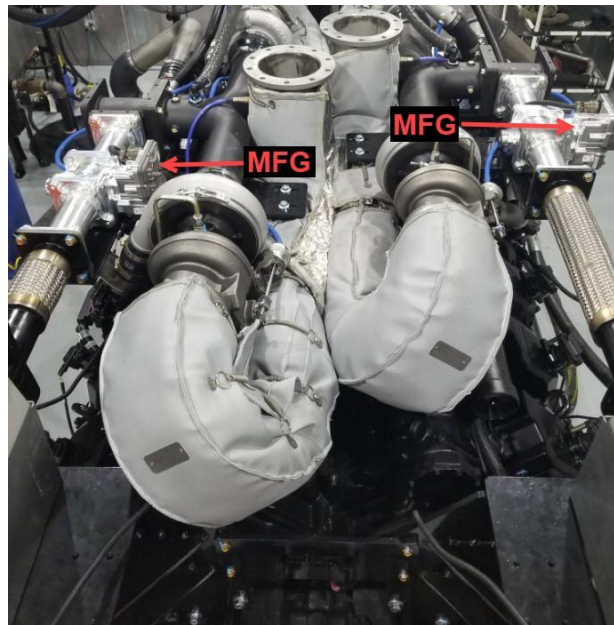

Figure 8

Operating Instructions - continued

Governors

PSI engines have an isochronous governor installed. The governor controls the movement of the throttle via a 0–5-volt signal and a ground provided by the Engine Control Module. The throttle allows the correct amount of air to enter the engine; this movement is monitored by using two internal throttle position sensors. The ECM monitors various engine sensors to determine what the correct throttle position should be.

Oil Pressure

The oil pressure reading shows the engine lubrication system pressure in pounds per square inch (psi) and should be checked frequently to ensure that the system is functioning correctly. Normal operating pressure is 58–94 psi at 1800 RPM at normal operating temperature (approximately 175° F). Should the pressure fluctuate or drop below 29 psi, stop the engine and find the cause. Do not operate the engine at lower-than-normal oil pressure.

CAUTION: Do not continue to operate your engine below the normal operating range. Severe engine damage could occur.

Coolant Temperature

The coolant temperature reading will indicate overheating which may arise from low coolant level, plugged radiator, loose fan belt or faulty thermostat. Coolant level should be checked daily.

CAUTION: If the engine continues to overheat, have the cooling system checked and serviced.

Voltage Reading

The PSI Energy product operates on a 24-volt electrical system. The voltage reading indicates the battery charging voltage. If the meter consistently indicates less than 26 volts or more than 30 volts under normal operating conditions, you should have the engine electrical system checked by a qualified service technician.

Tachometer/Hourmeter

The tachometer indicates the engine speed in hundreds of revolutions per minute (rpm). It serves as a guide to ensure that engine speed is set correctly.

The hour meter records the hours of operation and is used to determine when periodic maintenance is required.

Engine Pre-Lube Break In Requirements

The minimum requirements for engine start-up and break-in are listed below. These steps are necessary to ensure proper break-in of engine components and minimize premature engine wear.

It is the responsibility of the OEM to ensure the engine break-in procedure is followed during the production process and initial startup at your facility.

Time (Total Min)	Time (Min)	Engine Speed (RPM)	Engine Load	Test Procedure
Before Startup	2	0	0%	Pre-lubricate engine prior to initial startup using external pump.
0 - 15	15	1800	0%	Check engine coolant level and oil pressure at startup. Do not start engine at idle speed for initial break-in.
				Run the engine until the coolant temperature stabilizes. Continue to run for an additional 5 min.
15 - 45	30	1800	50%	Break-in
45 - 60	15	1800	75%	Break-in
60 - 70	10	1800	100%	Load check
-	-	1800	0-100%	Optional customer requested performance testing
End of Test	10	1800	0%	Cool down
Total	90			

External Pre-lubrication pump and fitting to connect to the QuickFit oil management system are available from PSI service parts department.

Pre-Lube Assembly

Maintenance Instructions

Your 53L comes equipped with a pre-lubrication system, which is designed to pressurize the oiling system to ensure all internally lubricated components have a layer of oil present during normal operation and start-up. All PSI 53L standby energy applications pre-lube systems will automatically run for 30 seconds every 12 hours, to achieve this one must ensure the pre-lube module is "ON". If the pre-lube assembly needs servicing, refer to the 53L service manual. The electrical diagram for the pre-lube assembly can be found in the 53L diagnostic manual.

WARNING:

- The pre-lube schedule is 30 seconds ON/12 hours OFF when the engine is in standby mode.
- The initial pre-lube cycle will run 2 minutes after the unit is powered on.
- The pre-lube cycle will start 12 hours after the engine is shutdown.
- The pre-lube cycle will not run while the engine is running.
- Use an emergency shutoff switch or similar switch to activate the Emergency Stop feature. If no switch is used to activate the Emergency Stop feature, the pre-lube cycle will continue to run until the battery source is disconnected.
- Manual pump operation is achieved by pressing the push button on the front of the pre-lube module.

Starting the Engine

WARNING: All internal combustion engines give off various fumes and gases while running. Do not start or run the engine in a closed or poorly ventilated building where exhaust gases can accumulate. Avoid breathing these gases as they may contain poisonous carbon monoxide, which can endanger your health or life if inhaled steadily for even a few minutes.

CAUTION: If the engine stalls or falters during starting, wait 3 to 4 seconds before re-engaging the starter. This will prevent possible damage to the starter and the engine. DO NOT operate the starter continuously for periods longer than 10 seconds at a time. An interval of at least 1- minute should be observed between cranking periods to protect the starter from overheating.

Natural Gas Fuel Systems

Turn on the gas supply to the engine. Turn the ignition key to the START position. After the engine starts, return the key to the ON position.

Stopping the Engine

Remove all load from the engine. Return the engine to idle speed (if available) and run engine for a few minutes at idle to allow the coolant and oil systems to cool down before turning the ignition switch to the OFF position.

WARNING: Avoid injury when checking a hot engine. Allow the engine to cool down before removing the radiator cap.

CAUTION: Before restarting the engine ensure that both the coolant system and the engine oil level have been checked and re-filled if necessary.

Fuel Recommendations Fuel Quality

PSI engines are designed to operate on pipeline quality natural gas with an LHV of approximately 920 BTU/scf. LPG engines and fuel systems are designed to operate on HD-5 or HD-10 specification LPG fuel. Fuel other than HD-5 or HD-10 may cause harm to the engine's emission control system and a warranty claim may be denied on this basis if operators can readily find the proper fuel. Use of any other fuel may result in your engine no longer operating in compliance with EPA emissions requirements.

Spark Plugs

Always use the spark plugs that are part of your preventative maintenance (PM) kit for your engine. Hotter or colder plugs, or similar plugs that are not exact equivalents to those supplied with your PM kits, can cause permanent engine damage, reduce the engine's useful life, and cause many other problems such as hard starting, spark knock and run-on. Installing new spark plugs regularly is one of the best ways to keep your engine at peak performance.

Power Loss at Higher Elevations & Temperatures

All engines will experience power loss when operated at elevations above sea level or at temperatures above 77 degrees Fahrenheit. Please see Technical Standard 56100030 - PSI Energy Derate Specification 53L for more details.

Maintenance Instructions

Initial Start Up Maintenance

The initial start-up checks must be made before putting the engine into service. Please refer to the Maintenance Schedule and perform the initial start-up operations in the sequence shown in column 1.

Routine Maintenance

Routine maintenance provides the best solution for making sure that the engine is ready when you are. The following are some routine service points:

- Make daily checks of the engine oil and coolant levels
- Repair any oil or coolant leaks immediately
- Check battery condition and cables frequently
- Keep the engine air filter clean
- Monitor engine coolant temperature
- Monitor engine oil pressure
- Check voltmeter and charging system

Engine Oil

To achieve proper engine performance and durability, it is important that you use only engine lubricating oils of the correct quality in your engine, ensure. Proper quality oils also provide maximum efficiency for crankcase ventilation systems, which reduces pollution.

A multi-viscosity, low-ash gas engine oil should be used. Straight weight engine oils are not recommended. Do not use oils that are formulated only for use in diesel engines.

SAE No.	Sulfated Ash Content by Weight	Engine Oil Capacity (min/max)	Recommended Oil
15w-40	0.25 - 0.5% by wt. API CD/CF or higher	154 qts / 180 qts	Chevron HDAX 5200 Low Ash Gas Engine Oil

Maintenance Instructions - continued

Low-Load Engine Operations

Operation of PSI HD engines at low-load conditions should be limited to no more than one (1) hour per twenty-four (24) hour period. If the application requires extended time at light loads, it is recommended that the engine load be increased to at least 70% of mechanical rating for a minimum of two (2) hours per fifty (50) hours of low-load operation, this defines a less than 30% of published prime rate mechanical load.

Exceeding the recommendation can result in:

- Abnormal high engine oil consumption
- Degradation in engine oil due to excessive combustion gas blow-by
- Accumulation of carbon deposits in the engine power cylinder, resulting in knock system malfunction
- Reduced life of engine power cylinder

Engine Coolant

The cooling system must be filled with a 50/50 mix of coolant and distilled water. A NAPS-free coolant (free from nitrates, amines, phosphates, and silicates) should be used. The coolant should be an organic acid technology (OAT) long-life variety, such as Chevron Delo XLC.

Variety	Freezing/Boiling Point (°F)	Recommended Type	Engine Coolant Capacity (gal)
OAT Long-Life Engine Coolant	-34 / 265	Chevron Delo XLC Antifreeze/ Coolant 50/50 Mix	26 gal

Make sure to check the coolant regularly, and change it as required to avoid damage to the cooling system. The cooling system must be filled with a 50/50 mix of coolant and water. Do not use undiluted antifreeze or straight water in the cooling system.

Engine Maintenance Guidelines - Standby Maintenance Table

PSI ENERGY ENGINE MAINTENANCE GUIDELINES			
56100029 Revision: 6 2023-03-22	Service Intervals		
20L, 32L, 40L, and 53L Standby	Initial 50 Hour Service¹	Annual Service	Every Two Years
Check for fluid leaks	X	X	
Check engine oil level	X	X	
Check coolant level	X	X	
Inspect drive belts for tension, cracks, splits, or glazing	X	X	
Inspect air cleaner filter element, replace as needed	X	X	
Inspect electrical system and harnesses for cuts, abrasions or wear	X	X	
Inspect all vacuum lines and fittings for cracks, breaks or hardening	X	X	
Inspect coolant hoses for cracks, swelling or deterioration	X	X	
Inspect fuel shut-off valves for leaks and proper operation	X	X	
Inspect gas piping and hoses for leaks or damage	X	X	
Check air induction piping for leaks	X	X	
Inspect automatic belt tensioners, replace if necessary	X	X	
Check intake manifold for vacuum leaks	X	X	
Inspect exhaust manifold for leaks	X	X	
Inspect exhaust piping for leaks	X	X	
Inspect O ₂ sensors and harness for damage/performance	X	X	
Inspect catalyst for mechanical damage and performance	X	X	
Sample engine oil as needed	X	X	
Change engine oil and filter ²	X	X	
Adjust intake and exhaust valve clearance	X	X	
Clean debris from radiator core	X	X	
Tighten all hose clamps on CAC piping boots	X	X	
Drain LPL vaporizer oil build up (if LP fuel system is installed)	X	X	
Inspect ignition coils and harness		X	

Replace spark plugs			X
Drain, flush, and replace engine coolant ²			X
Replace fan and water pump belts			X
Replace ignition coils			X
Replace throttle bodies			X

1: Perform after initial 50 hours of engine operation, and 50 hours after top end or overhaul service

2: Oil and coolant change intervals can be extended only with a regularly scheduled sampling program

The service life of an engine is influenced by several factors including correct installation, operating at proper rated load, proper service and inspection by trained technicians, and the use of approved engine oil, filters, and coolant.

Engine Maintenance Guidelines — Prime

PSI ENERGY ENGINE MAINTENANCE GUIDELINES

56100029 Revision: 6 2023-03-22	Service Intervals								
32L, 40L, and 53L Prime	Initial 50 Hour Service ¹	Daily	Every 250 Hrs	Annual Service	Every 750 hrs	Every 4000 hrs	Every 8760 Hrs	Every 20,000 hrs (Top End)	Every 40,000 hrs (Overhaul)
Check for fluid leaks	X	X							
Check engine oil level	X	X							
Check coolant level	X	X							
Inspect drive belts for tension, cracks, splits, or glazing	X		X						
Inspect air cleaner filter element, replace as needed	X		X						
Sample engine oil as needed	X		X						
Drain, flush, and replace engine coolant ²				X					
Replace fan and water pump belts				X					
Change engine oil and filter ²	X			X ⁴					
Adjust intake and exhaust valve clearance	X				X				
Inspect electrical system and harnesses for cuts, abrasions or wear	X				X				
Inspect all vacuum lines and fittings for cracks, breaks or hardening	X				X				
Inspect automatic belt tensioners, replace if necessary	X				X				
Inspect coolant hoses for cracks, swelling or deterioration	X				X				
Inspect fuel shut-off valves for leaks and proper operation	X				X				
Inspect gas piping and hoses for leaks or damage	X				X				
Inspect air induction piping for leaks	X				X				
Inspect intake manifold for vacuum leaks	X				X				
Inspect exhaust manifold for leaks	X				X				
Inspect exhaust piping for leaks	X				X				
Inspect O ₂ sensors and harness for damage/performance	X				X				
Inspect catalyst for mechanical damage and performance	X				X				
Clean debris from radiator core	X				X				

Tighten all hose clamps on CAC piping boots	X				X				
Drain LPL vaporizer oil build up (if LP fuel system is installed)	X				X				
Inspect ignition coils, coil boots, and harness					X				
Replace spark plugs					X				
Replace throttle bodies						X			
Inspect O ₂ sensor performance, replace if necessary ³							X		
Inspect catalyst performance, replace if necessary ³							X		
Replace ignition coils and boots							X		
Replace coolant pumps							X		
Replace battery charging alternator							X		
Replace cylinder heads								X	
Replace rocker arm assemblies								X	
Replace turbocharger assemblies								X	
Replace exhaust manifold assembly and gaskets								X	
Replace cooling fan hub								X	
Replace thermostats, gaskets and O-rings								X	
Clean and Inspect fuel mixers								X	
Replace MFG or EPR valves								X	
Replace fuel lock-off valves								X	
Replace crankcase ventilation assembly								X	
Replace oil coolers								X	
Replace camshaft, bearings, seals, lifters, pushrods, and timing gears								X	
Replace piston and connecting rod assemblies and cylinder liners									X
Replace crankshaft assembly, bearings and seals									X
Replace oil pump									X
Replace front accessory drive pulleys, idlers and seals									X

1: Perform after initial 50 hours of engine operation, and 50 hours after top end or overhaul service.

2: Oil and coolant change intervals can be extended only with a regularly scheduled sampling program.

3: Expected life of catalysts and O₂ sensors is 8760 hours.

4: Oil and filter change should be performed annually or every 750 hours of engine operation, whichever comes first.

The service life of an engine is influenced by several factors including correct installation, operating at proper rated load, proper service and inspection by trained technicians, and the use of approved engine oil, filters, and coolant.

Engine Maintenance Guidelines — Limited Time Power

PSI ENERGY ENGINE MAINTENANCE GUIDELINES										
56100029 Revision: 6 2023-03-22	Service Intervals									
32L, 40L, and 53L Limited Time Prime	Initial 50 Hour Service ¹	Daily	Every 250 Hrs	Annual Service	Every 750 hrs	Every 4000 hrs	Every 8760 Hrs	Every 16,000 hrs (Top End)	Every 32,000 Hrs (Power Cell)	Every 48,000 hrs (Overhaul)
Check for fluid leaks	X	X								
Check engine oil level	X	X								
Check coolant level	X	X								
Inspect drive belts for tension, cracks, splits, or glazing	X		X							
Inspect air cleaner filter element, replace as needed	X		X							
Sample engine oil as needed	X		X							
Drain, flush, and replace engine coolant ²				X						
Replace fan and water pump belts				X						
Change engine oil and filter ²	X			X ⁴						
Adjust intake and exhaust valve clearance	X				X					
Replace spark plugs					X					
Inspect electrical system and harnesses for cuts, abrasions or wear	X				X					
Inspect all vacuum lines and fittings for cracks, breaks or hardening	X				X					
Inspect automatic belt tensioners, replace if necessary	X				X					
Inspect coolant hoses for cracks, swelling or deterioration	X				X					
Inspect fuel shut-off valves for leaks and proper operation	X				X					
Inspect gas piping and hoses for leaks or damage	X				X					
Inspect air induction piping for leaks	X				X					
Inspect intake manifold for vacuum leaks	X				X					
Inspect exhaust manifold for leaks	X				X					
Inspect exhaust piping for leaks	X				X					
Inspect O ₂ sensors and harness for damage/performance	X				X					
Inspect catalyst for mechanical damage and performance	X				X					
Clean debris from radiator core	X				X					

Tighten all hose clamps on CAC piping boots	X					X					
Drain LPL vaporizer oil build up (if LP fuel system is installed)	X					X					
Inspect ignition coils, coil boots, and harness						X					
Replace throttle bodies							X				
Inspect O ₂ sensor performance, replace if necessary ³								X			
Inspect catalyst performance, replace if necessary ³								X			
Replace ignition coils and boots								X			
Replace coolant pumps								X			
Replace battery charging alternator								X			
Replace turbocharger assemblies								X			
Replace cylinder heads									X		
Replace rocker arm assemblies									X		
Replace exhaust manifold assembly and gaskets									X		
Replace cooling fan hub									X		
Replace thermostats, gaskets and O-rings									X		
Clean and Inspect fuel mixers									X		
Replace MFG or EPR Valves									X		
Replace fuel lock-off valves									X		
Replace crankcase ventilation assembly									X		
Replace oil coolers									X		
Replace camshaft, bearings, seals, lifters, pushrods, and timing gears									X		
Replace piston and connecting rod assemblies and cylinder liners										X	
Replace crankshaft assembly, bearings and seals											X
Replace oil pump											X
Replace front accessory drive pulleys, idlers and seals											X

1: Perform after initial 50 hours of engine operation, and 50 hours after top end or overhaul service.

2: Oil and coolant change intervals can be extended only with a regularly scheduled sampling program.

3: Expected life of catalysts and O₂ sensors is 8760 hours.

4: Oil and filter change should be performed annually or every 750 hours of engine operation, whichever comes first.

The service life of an engine is influenced by several factors including correct installation, operating at proper rated load, proper service and inspection by trained technicians, and the use of approved engine oil, filters, and coolant.

Engine Maintenance Guideline-Standby

Check for fluid level leaks: Look for evidence of fluid leaks on the engine block, radiator, and underneath the engine. If a leak is found, follow the leak back to its source and repair the leak.

Check engine oil level: When checking the oil level, the engine should be off. If the engine has been running allow it to sit for at least 5 minutes before checking the oil level. Pull the dipstick, wipe it with a clean rag, re-insert it into the dipstick tube and remove it again, and check the oil level. The oil level should be between the low and high marks on the dipstick as shown in figure 5. If the oil level is low, add oil as needed.

Do not overfill.

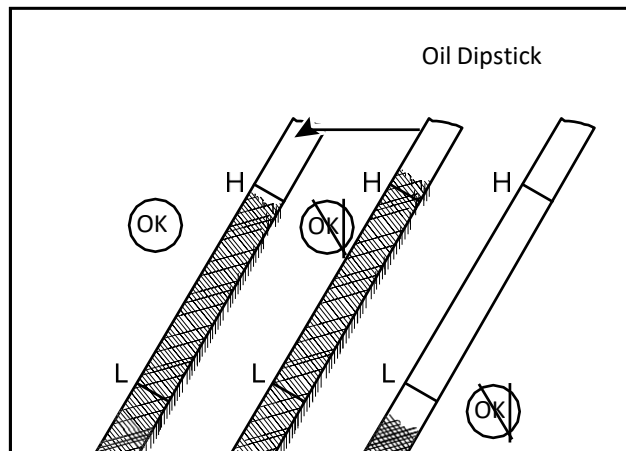

Figure 9

Maintenance Instructions - continued

It is normal to add some oil between oil changes. The amount will vary with the severity of operation. When adding or replacing engine oil, be sure the oil meets or exceeds the recommended specification.

Check coolant level: Check the coolant level of the radiator daily and only when the engine is Cool. Do this just prior to starting the engine for the first time each day. Maintain the coolant level at $\frac{3}{4}$ to $1\frac{1}{2}$ inches below the filler neck seat of the radiator when the coolant is cold. Whenever coolant level checks are made inspect the condition of the radiator cap rubber seal. Make sure it is clean and free of any dirt particles which would keep it from seating on the filler neck seat. Rinse off with clean water if necessary. Also make sure that the filler neck seat is free of any dirt particles. Radiator coolant capacity should remain at 39.0 gallons to ensure optimal operating temperatures.

WARNING: Never remove the radiator cap under any conditions while the engine is operating or hot. Failure to follow these instructions could result in damage to the cooling system, engine, or cause personal injury. To avoid having scalding hot coolant or steam blow out of the radiator, use extreme caution when removing the radiator cap from a hot radiator. If possible, wait until the engine has cooled, then wrap a thick cloth around the radiator cap and turn slowly to the first stop. Step back while the pressure is released from the cooling system. When all the pressure has been released, press down on the cap and remove it slowly.

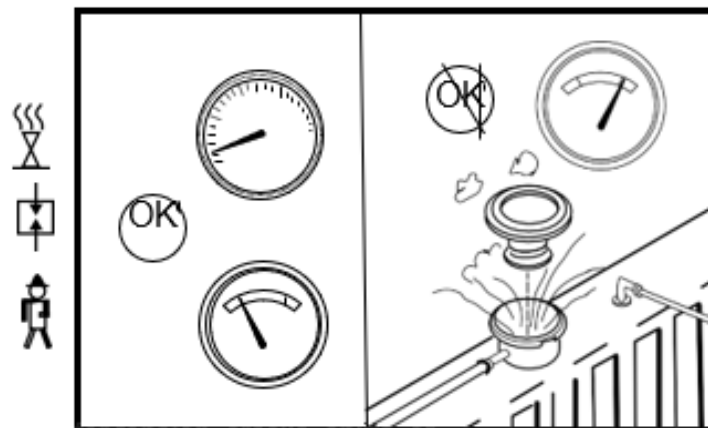

Figure 10

Inspect drive belts for tension, cracks, splits, or glazing: Make sure the belts are fully engaged on all pulleys and riding in the correct grooves. Look for cracks on the ribs of the belt, fraying at the edges of the belt, or any other signs of unusual wear. Pull on the belt and check that the automatic tensioner is moving.

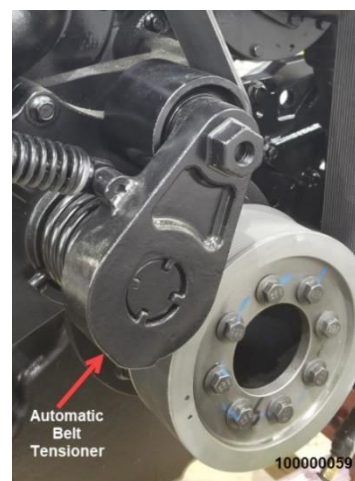

Figure 11

Maintenance Instructions - continued

Sample engine oil as needed:

- a) Locate the oil sample valve (Figure 8) on the left side of the engine block underneath the intake manifold. Remove the protective cap from the valve.
- b) While the engine is running and at operating temperature, press the end of the valve to dispense a small amount of oil into a container. This will purge debris and stagnant oil from the valve prior to taking a sample for analysis. Caution: The oil will be hot, and it dispenses quickly from the valve. Wear gloves and safety glasses.
- c) Dispense an oil sample into a clean, unused oil sample bottle. Be sure to record all the necessary engine data when taking the sample, such as engine serial number, total run hours, run hours since last oil change, etc.
- d) Reinstall the dust cap on the sample valve.



Figure 12

Change engine oil and filter:

- a) If the engine is cold, start it and allow it to run for a few minutes to get the oil warm and circulating. Shut the engine down and disconnect the negative battery cable from the battery.
- b) Remove the dust cap from the oil drain valve fitting (Figure 9) and attach a collection hose to the fitting. Drain the oil into a suitable container. When the oil has completely drained, close the valve, remove the hose, and reinstall the dust cap. Dispose of the drained oil in accordance with environmental regulations.



Figure 13

- c) Remove the old oil filters and dispose of them in accordance with environmental regulations. Make sure the gasket from the old filter does not remain stuck to the engine.
- d) Apply a thin layer of oil to the gasket on the new filters.

Maintenance Instructions - continued

- e) Tighten the filter by hand until the gasket contacts the sealing surface, continue to tighten the filter by hand, tighten each oil filter a 1/2 turn past hand tighten.
- f) Open the filler cap and add engine oil (up to 154 quarts) until the level reaches the high mark on the dipstick. Reinstall the oil filler cap.
- g) Start the engine and run at idle with no load applied. Inspect the engine and filters for any oil leaks.
- h) Shut the engine down, wait at least 5 minutes for the oil to drain back into the sump, and recheck the oil level. More oil may need to be added to replace the oil that filled the filters.

Inspect electrical system and harnesses for cuts, abrasions, or wear: Make sure the harness is not pulled too tight over any sharp corners or resting on any hot engine components. Look for any loose, damage, or melted wires.

Inspect all vacuum lines and fittings for cracks, swelling, or deterioration: Carefully look over all hoses, tubing, and silicone boots on the engine for any cracking, splitting, swelling, melting, abrasion, or other damage. Replace any damaged parts.

Inspect fuel shut-off valves for leaks and proper operation:

- a) With the engine off, remove the plug from the test port on the lockoff closest to the EPR.
- b) Connect a pressure gauge capable of reading inches of water column. There should be no pressure between the lockoff and the EPR with the engine off. If pressure rises with the gauge installed, the lockoff is leaking and needs to be replaced.

Inspect gas piping and hoses for leaks and damage: Check all-natural gas piping for damage. Spray any joints in the natural gas piping with soapy water and watch for bubbles. Repair any leaks. Inspect all flexible hoses for kinks damage to the steel braids. Replace any damaged flex hoses.

Maintenance Instructions - continued

Inspect air induction piping for leaks: Check the hose clamps (see Figure 14) on all the silicone boots on the charge air piping and make sure they are tight and fully clamped on both the boot and the underlying pipe. Inspect the silicone boots for damage or leaks and replace any damaged boots.

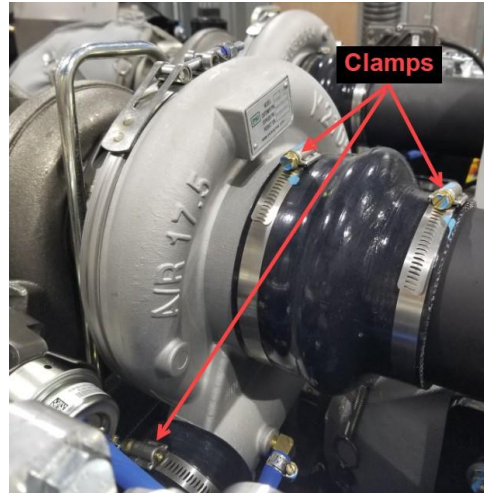

Figure 14

Inspect air intake manifold for vacuum leaks: Check all bolts on the intake manifold to ensure they are tight, and all surfaces are properly sealed (Figure 15). Check the MAP sensor to make sure it is properly installed.



Figure 15

Inspect exhaust manifold for leaks: Check for exhaust and coolant leaks along the length of the exhaust manifold (Figure 16). Make sure all exhaust manifold bolts are tight.



Figure 16

Maintenance Instructions - continued

Inspect O2 sensors and harness for damage/performance: Inspect wiring on pre-catalyst O2 sensors (Figure 17), and post-catalyst O2 sensors (refer to application reference sheet for placement) and check for any damaged caused by contact with hot exhaust components, or any other wire damage. Make sure harness connections are tight and the O2 sensors are tightly threaded into the exhaust piping. Connect the engine diagnostic software and check for any O2 sensor faults; diagnose and repair as necessary.



Figure 17

Inspect catalyst for mechanical damage and performance: Remove the exhaust inlet pipe from the catalyst and look inside (Figure 18). Inspect the substrate for damage, melting, and clogging. Connect the engine diagnostic software and check for emissions-related faults; diagnose and repair as necessary.



Figure 18

Clean debris from radiator core: Inspect the exterior of the radiator for obstructions. Remove all bugs, dirt or foreign material with a soft brush or cloth. Use care to avoid damaging the core fins. If available, use low pressure compressed air or a stream of water in the opposite direction of the normal air flow. Use extreme care if using a pressure washer – high pressure water could fold over the cooling fins or damage the cooling passages. Keep in mind that in most configurations these engines use a pusher fan that takes air from the engine side of the radiator and pushes it through, so the buildup will occur on the side of the radiator with the fan. The fan guards may need to be removed to provide access to the radiator and CAC cores.

Maintenance Instructions - continued

Clean debris from radiator core:

Inspect the exterior of the radiator for obstructions. Remove all bugs, dirt or foreign material with a soft brush or cloth. Use care to avoid damaging the core fins. If available, use low pressure compressed air or a stream of water in the opposite direction of the normal air flow. Use extreme care if using a pressure washer – high pressure water could fold over the cooling fins or damage the cooling passages. Keep in mind that in most configurations these engines use a pusher fan that takes air from the engine side of the radiator and pushes it through, so the buildup will occur on the side of the radiator with the fan. The fan guards may need to be removed to provide access to the radiator and CAC cores.

Measure intake and exhaust valve clearance, reset as necessary:

Note:

Measure and adjust while engine is cold.

- a) Remove wiring harness from starter.
- b) Remove starter.
- c) Install the barring over tool as shown in (Figure 19) (part #Z52500309).



Figure 19

- d) Remove the timing access cover on the flywheel to expose the timing marks on the flywheel surface as shown in Figure 20. Remove all twelve valve covers from the engine.



Figure 20

Maintenance Instructions - continued

- e) Using a 1/2" ratchet at the end of the spring-loaded barring over tool rotate the engine until it is at TDC #1.
- f) Check the rockers when cylinder 1 is at TDC (Left side of the engine closest to the rear (Flywheel) end of the engine). If cylinder 1 is at TDC the valves shown below in blue can be adjusted. If cylinder 11 is at TDC the valves shown below in red can be adjusted. (Refer to Figure 21)

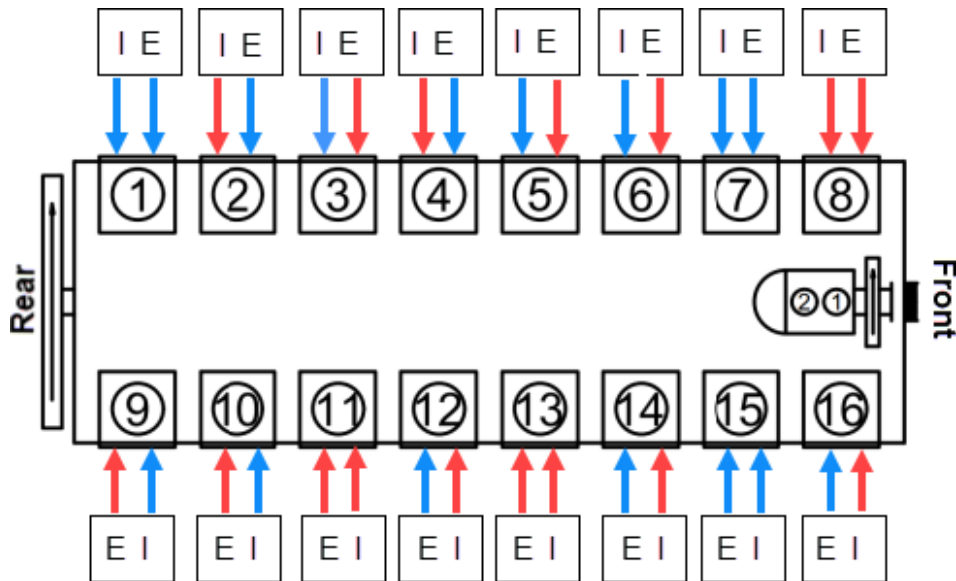

Figure 21

- g) Use feeler gauges (Figure 22) to check the clearance between the rocker arm and the valve bridge (Figure 23). Lash should be set to 0.55mm (0.022 in) for the intake and 1.00mm (0.039 in) for the exhaust. Repeat on all other valves with arrows of the same color as shown above.



Figure 22

1000000070

Maintenance Instructions - continued

- h) Rotate the crankshaft 360 degrees until the timing mark is back at TDC #1 again. If the valves with the blue arrows were checked first, the valves with the red arrows may now be checked. If the valves with the red arrows were checked first, the valves with the blue arrows may now be checked.
- i) Check lash on all rockers that were not previously checked. Adjust as necessary.
- j) Reinstall valve covers.

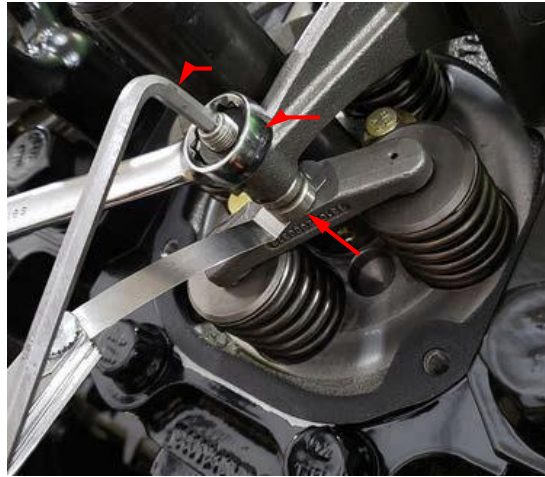

Figure 23

Tighten all hose clamps on CAC piping boots: Check the tightness of the clamps at each silicone boot on the CAC system as shown (Figure 24 and 25). Start at the turbocharger compressor outlet and follow the piping to the charge air cooler inlet, then from the charge air cooler outlet to the throttle body. Tighten as necessary.

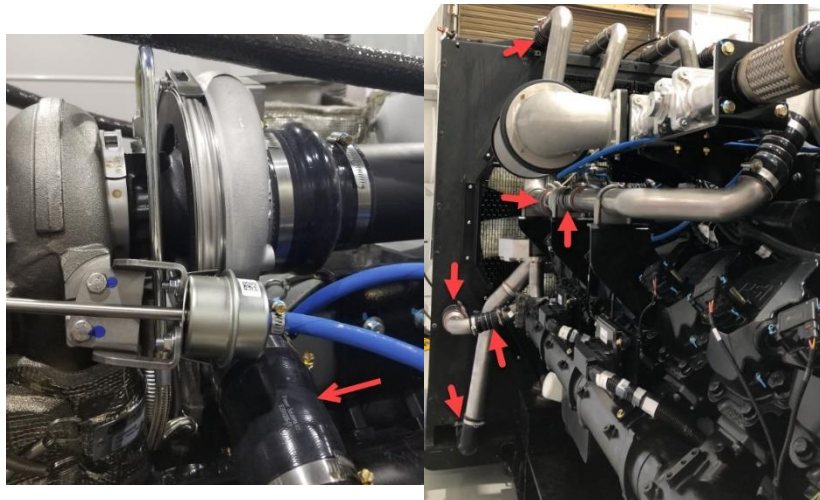

Figure 24

Figure 25

Typical to both sides of the engine

Maintenance Instructions - continued

Drain LPL vaporizer oil buildup (if LP fuel system is being used):

Remove the vapor hose from the propane vaporizer and look for oil/paraffin buildup inside. Clean out any accumulated oils. Check the vapor hose for residue and clean if present.

Inspect ignition coils, coil boots, and harnesses:

Check for any damage to the ignition coils, any evidence of heat damage to the coil boots (melting, burn marks, cracking), and any damage to the ignition coil harness as shown in Figure 26 (typical of 12). Repair/replace any damaged components.



Figure 26

Replace spark plugs:

- a) Remove the spark plugs.
- b) Inspect the spark plugs upon removal (Figure 27). Look at the porcelain around the center electrode of each plug. You can detect many engine problems from the color and type of deposits that have built up on the white porcelain. For example, if the deposits are a glossy brown, that cylinder is burning excess oil. If the deposits are a very dark gray or sooty black color, your engine is running rich, and you are burning excess fuel. The optimum color of the deposits on the porcelain is light tan or light brown. This shows optimum fuel mixture and proper engine running conditions. If the deposits are almost white, the engine may be running excessively lean.
- c) Install the new spark plugs and torque to 22 lb-ft. Use only spark plugs purchased from PSI Parts & Service. NOTE: The engine is equipped with iridium-tipped spark plugs which are set to the proper gap by the manufacturer. Do not attempt to adjust the spark plug gap; this could damage the tips.



Figure 27

Maintenance Instructions - continued

Drain, flush, and replace engine coolant:

Draining the Cooling System:

- a) Shut off engine and allow it to cool below 100°F (38°C) and remove the overflow tank filler cap.
- b) Attach a hose to the radiator drain valve and run the hose to a container large enough to hold the contents of the cooling system – approximately 65 gallons. Open drain valve.
- c) Inspect cooling system hoses and clamps and adjust/tighten as necessary. Replace any worn hoses or clamps before adding new coolant to the system.
- d) After the coolant has stopped draining, close off all drain plugs.
- e) Open coolant drains on both oil coolers (as shown in Figure 28, typical of both sides of engine), and allow the coolant to drain. Close the drains when empty.

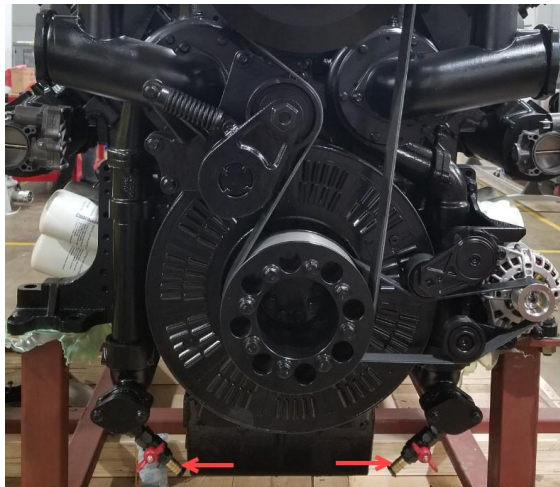

Figure 28

Flushing the Cooling System:

- a) Connect a coolant pump to the proper radiator fill fitting. **CAUTION:** Use of a fill pump is required to properly purge the system of air during a fill procedure. Coolant should be added to the overflow tank filler neck for top-off only. Failure to do so can result in engine damage.
- b) Fill the system with clean deionized/distilled water. Tap water is acceptable but is not preferred.
- c) Disconnect the fill pump. Replace the radiator cap or overflow tank filler cap.
- d) Start the engine and run at 1800 RPM to thoroughly circulate the deionized water through the cooling system. Run the engine for at least 30 minutes.
- e) Shut off the engine and allow it to cool below 100°F (38°C) and remove the radiator cap or overflow tank filler cap.
- f) Drain the water from the cooling system and dispose of properly.

Maintenance Instructions - continued

Refilling the Cooling System:

- a) Connect a coolant pump to the proper radiator fill fitting. **CAUTION:** Use of a fill pump is required to properly purge the system of air during a fill procedure. Coolant should be added to the overflow tank filler neck for top-off only. Failure to do so can result in engine damage.
- b) Fill the system with fresh PSI-approved pre-mixed coolant.
- c) Disconnect the pump. Replace the radiator cap or overflow tank filler cap.
- d) Start the engine and run at 1800 RPM to thoroughly circulate the coolant and purge the system of air bubbles. Run for a minimum of 30 minutes.
- e) Shut the engine down and allow it to cool below 100°F (38°C) so you can safely remove the radiator cap or overflow tank cap.
- f) Top off the cooling system to the full cold line using PSI-approved pre-mixed coolant.
- g) Replace and tighten the radiator cap.

Replace fan and alternator belts:

- a) Remove the fan guards from the radiator to allow access to the belts and fan.
- b) Remove the fan from the fan drive.
- c) Use a 36mm socket wrench on the fan belt tensioner arm. Pull the wrench to remove the tension from the belt and remove the belt.
- d) Insert a ½" drive ratchet or breaker bar into the square hole on the automatic belt tensioner on the left side of the engine. Pull the ratchet (see Figure 29) to take the tension off the alternator belt and remove the belt (as shown).



Figure 29

Maintenance Instructions - continued

- a) Install a new belt on the alternator. Pull the ratchet to move the tensioner pulley out of the way, slip the belt into place, and slowly allow the tensioner pulley to apply tension to the belt. Check the belt on all pulleys to ensure it is
- b) properly aligned and engaging all grooves as shown in Figure 30.
- c) Install a new fan belt over the crank pulley. Pull the 36 mm wrench to move the tensioner pulley out of the way, slip the belt in place over the fan drive pulley, and slowly allow the tensioner pulley to apply tension to the belt. Check that the belt is properly aligned and engaging all grooves.
- d) Reinstall the fan. Use blue threadlock on the fan hardware and tighten in a star pattern. Torque the fan bolts to 59 lb.-ft.

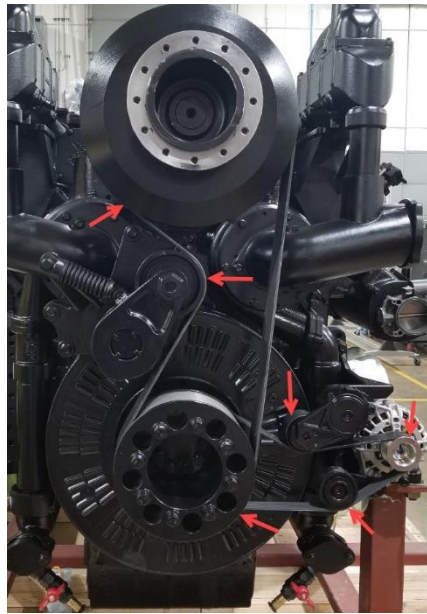

Figure 30

- e) Reinstall the fan guards.

Maintenance Instructions - continued

Replace ignition coils and boots:

- a) Remove all ignition coils and boots (Figure 31). Save all hardware.



Figure 31

- b) Apply a pea-sized amount of "Super Lube" (Figure 32) dielectric grease at the spring and additional thin layer around the interior of the coil boot to lubricate contact with the spark plug. Install new boots and coils on the engine using the existing hardware.



Figure 32

Replace throttle bodies:

- a) Disconnect the CAC tubing from the throttle body.
- b) Unplug the harness from the throttle body.
- c) Remove the inlet adapter from the throttle body (as shown in Figure 33). Make sure the O-ring from the throttle body does not stick to the inlet adapter; if it does, remove it.

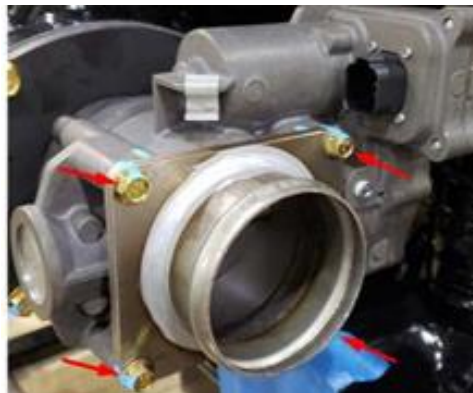

Figure 33

Maintenance Instructions - continued

- d) Loosen the hardware securing the throttle body to the engine (as shown in Figure 34) and remove the throttle body. Make sure the O-ring from the throttle body does not stick to the inlet flange; if it does, remove it.
- e) Install the new throttle body in the same orientation as the old one.
- f) Install the inlet adapter on the new throttle body.

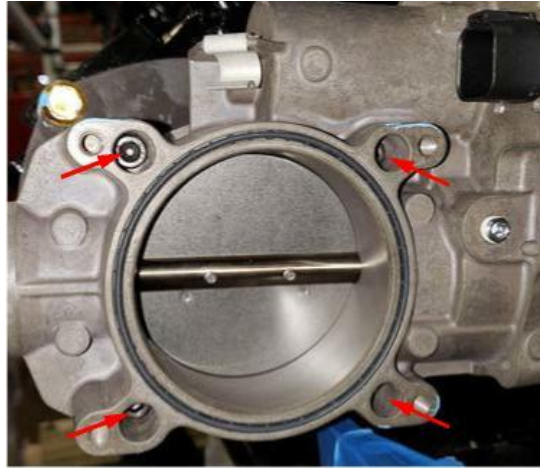

Figure 34

- g) Connect the engine harness to the new throttle body.
- h) Reinstall the CAC tubing and tighten all hose clamps as shown in Figure 35.



Figure 35

LONG-TERM STORAGE

One to Six Months

Storage preparation:

If the engine or machine is to be placed in storage for a period of one to six months, it is recommended that the following steps be followed:

- Store indoors with a consistent temperature and low humidity, if possible.
- Protect the air cleaner inlet from water entry.
- Protect the exhaust outlet or muffler outlet from water entry.
- Check the coolant strength and top off radiator.
- Use a weatherproof storage bag, with desiccant bag inside, for extra protection. **At the end of each and every three-month storage period:**
- Carefully check all drive belts, paying particular attention to the point where the straight run of the belt starts to bend around the pulley. Check the vee groove in the pulley for corrosion
- Check the level of coolant (must be anti-freeze inhibited).
- Check the level of oil in the sump on the dipstick.
- Rotate crankshaft by hand to re-distribute load on the valve train and to keep seals from becoming stuck. Be sure engine rests in a different position (-180 degrees).
- If battery is still installed in unit, slowly recharge battery. This can be done every month to extend the service life of the battery.

Storing an engine over Six months:

Storage preparation:

Follow all above recommended procedures, plus do the following:

- Drain the engine crankcase and refill with recommended oil.
- Change the oil filter.
- Disconnect and remove the battery.
- Clean exterior surface of the engine.
- If the engine is equipped with an automotive type clutch or PTO clutch, make sure that the clutch is disengaged.

LONG-TERM STORAGE - continued

Storing an engine over Six months:

At the end of each six-month storage period:

- Check that existing preservation of all external surfaces is sound and complete, paying particular attention to crankshaft lip seal surfaces, re-preserve as necessary.
- Ensure that all open aperture protective covers (air intake, exhaust manifolds, etc.) are securely positioned.
- Perform all 3-month inspections previously listed.

Note: The lubricating oil and fully primed filter must be replaced with oil to the listed specification every twelve months, even though the oil has not been used. Oil left standing in an engine will oxidize and can be contaminated by condensation within the crankcase.

Removing an engine from storage

When removing an engine or machine from storage, the following steps should be taken to be sure the engine is in proper operating condition:

- Remove all protective storage coverings from engine / machine.
- Check engine oil level. If the engine has been dormant for over 12 months change the engine oil and filter.
- Check engine coolant level. If the engine has been dormant for over 12 months, drain and refill with fresh coolant.
- Inspect the drive belt system. Check for cracks in belt and corrosion on pulleys. Replace and clean as needed. If applicable grease pulley bearings.
- Install a new or fully charged battery. If installing a used battery check electrolyte level.
- Inspect all engine systems thoroughly for leaks, tears, broken wires, etc.
- Rotate engine by hand at least 360 degrees before attempting to start to be sure engine rotates smoothly.
- When starting the engine watch all gauges closely. Be sure engine oil pressure rises within 10 seconds of engine run time. If no oil pressure shut down engine.
- Allow engine to run at idle for approximately 5 minutes, then raise engine to a 'high idle', 1000-1500 rpm and bring to full operating temperature. Watch all gauges closely, if any system is out of specification shut down engine immediately and find cause.

After the engine has successfully reached operating temperature shut down and re-check all fluid levels and systems.

APPENDIX: USING THE 4G SOFTWARE

Your PSI HD engine is controlled by two engine control modules (ECUs). The primary ECU controls the left side of the engine, and the secondary ECU controls the right side of the engine. To monitor engine parameters, record plot files, and check fault codes, the ECUs must be connected to a computer via an ECOM cable. ECOM cables are available through the PSI Aftermarket Parts Department. ECOM cables ship with a CD containing the required installation files for the software.

To install the 4G software, follow the instructions included on the ECOM cable CD. Be sure to install the ECOM cable driver first, then the 4G software.

Connecting to the Engine

To connect to the engine, plug the ECOM cable into the white diagnostic connector located on the left side of the engine near the ECUs. Plug the USB cable from the ECOM into your computer and start the 4G software. You will be asked for a password. The password can be found on the CD supplied with the ECOM cable. If entering a password for the first time, be sure to check the box marked "Save Password and SIN" so you won't have to re-enter the password next time you open the software. Do not check the "Single Serial Number Access" box.

Press OK, and the software will open. If you are connected, the status bar at the top of the screen will have a green box that says "Connected".

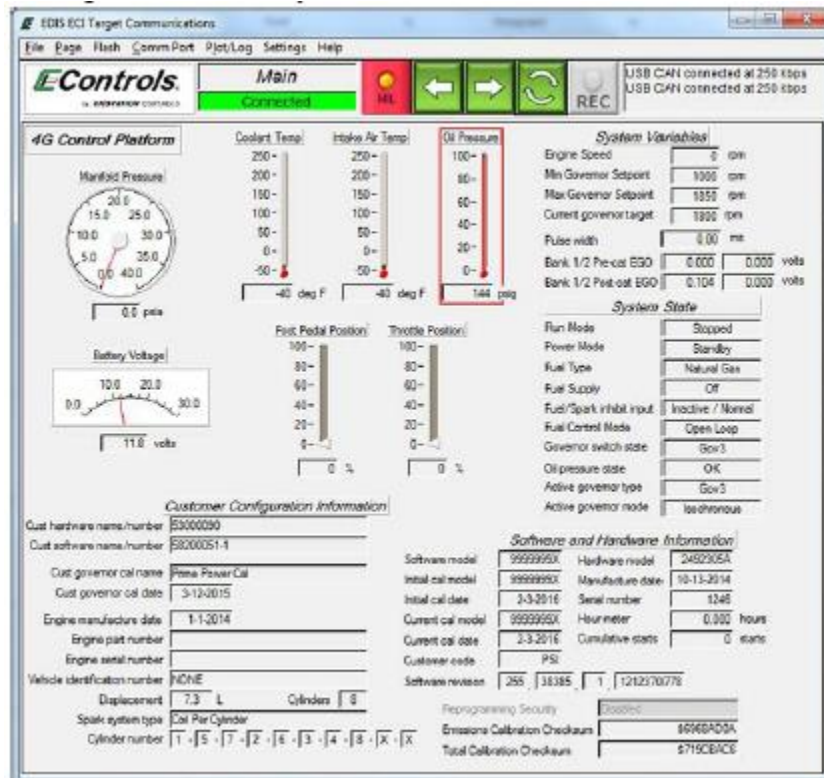

USING THE 4G SOFTWARE - continued

If your computer will not connect, you may need to briefly crank the engine to get the ECUs out of sleep mode. Begin a start sequence on the engine, and once the engine starts to crank stop it. This should wake the ECUs up and it should connect to the computer.

By default, the engine will connect to the primary (master) ECU first. To connect to the secondary (slave) ECU, open the 4G software again. You can have two copies of the software running at once. Once the password is entered, and the window is opened, click "Comm Port" on the menu bar at the top of the window, then click "Configure ECOM..." In the ECOM configuration window, change the Target CAN Address from 0 to 1 and press OK.

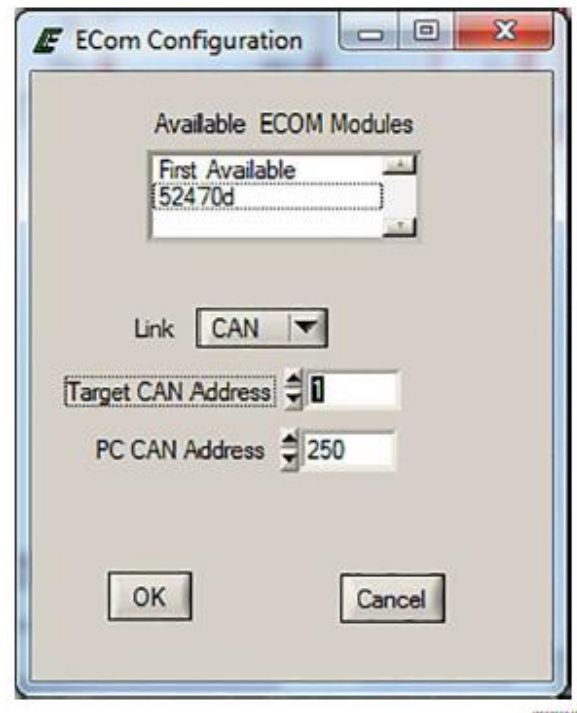
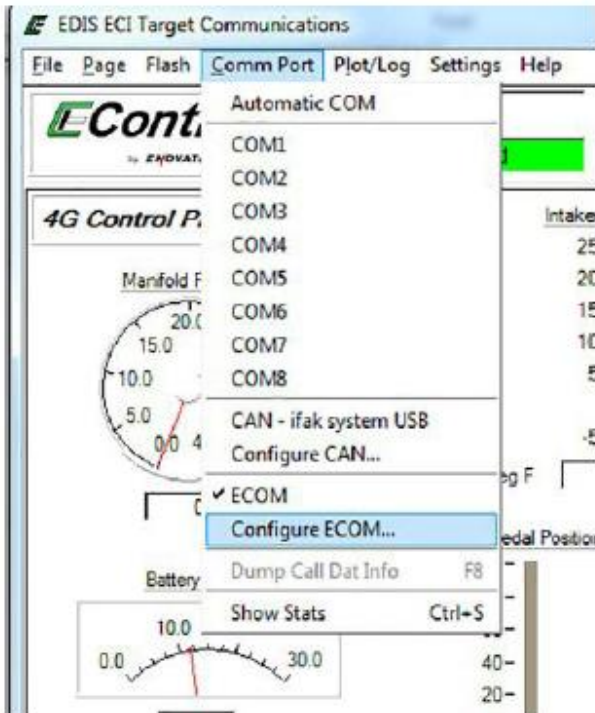

Unplug the ECOM cable from the USB port on your computer and plug it back in again to reset the connections. You should now have one window reading the Master ECU data and one reading the slave ECU data. To verify this, navigate to the Marine page by clicking Page on the menu bar at the top of the screen and selecting Marine. On the left side of the page, you'll see a heading titled "Multi-Engine Configuration". Multi-engine status will display either Master/Single for the master side or Slave for the slave side, depending on which ECU the software is connected to.

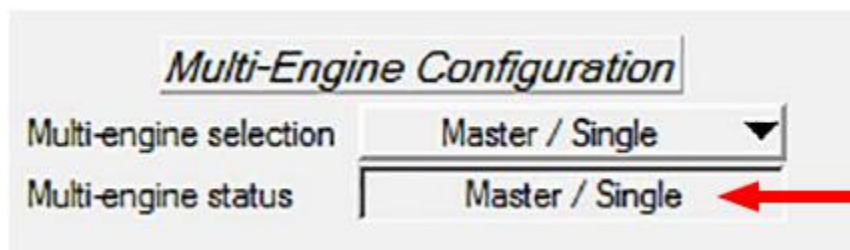

USING THE 4G SOFTWARE - continued

Checking Faults

At the top of the screen, click on "Page" and then click on "Faults".

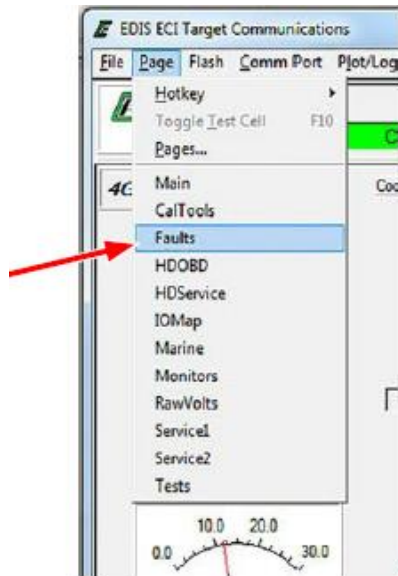

It may take some time for all the data to populate when opening the Faults window. You also may get notices about the connected ECU having more fault definitions than the 4G software. This is OK, it just means your 4G software is an older version. The software will still function normally.

There are three boxes at the bottom of the Faults page — Historic Faults, Active Faults, and Pending Faults. Historic faults are faults that occurred in the past, Active Faults are faults that are occurring right now, and Pending Faults are faults where a parameter is above or below a threshold that will cause a fault, but not enough time has passed for the fault to become active yet.

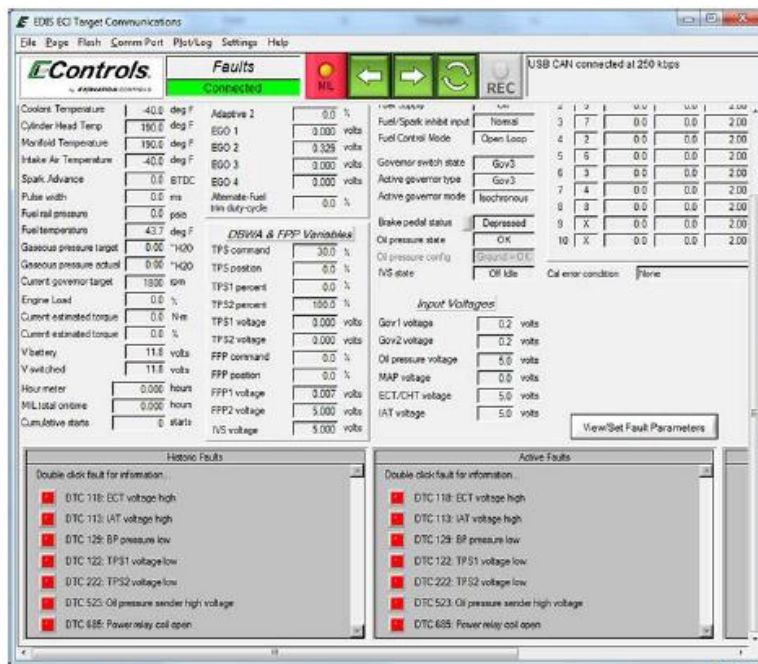

USING THE 4G SOFTWARE - continued

To get more information on a historic fault, double-click on the fault. This window will open.

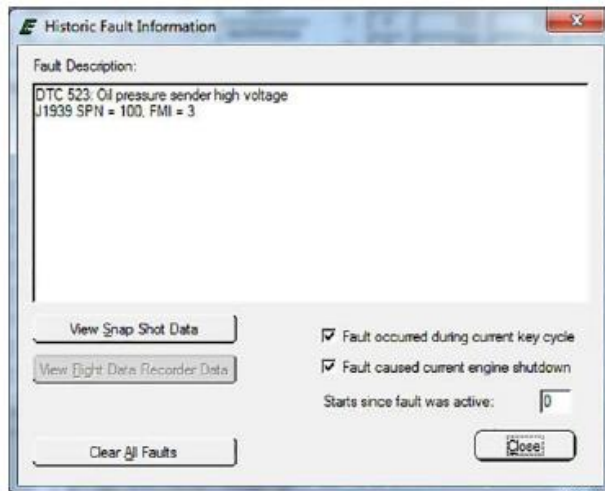

Fault occurred during current key cycle: This box will be checked if the fault has happened since the last time the engine was started.

Fault caused current engine shutdown: This box will be checked if the engine was shut down because of this fault. There can sometimes be more than one fault that triggers a shutdown at the same time.

Starts since fault was active: This counter goes up with each engine start since the fault went from active to historic. This can be particularly useful when troubleshooting because it helps eliminate "red herrings". If you have an unexpected shutdown and are showing three historic faults, two with 0 starts since fault was active and one with 27, you can focus on faults with 0 starts, since they are more recent.

View Snapshot Data: Pressing this button will bring up a window that shows engine hours at the time of the fault along with a bunch of engine parameters at the time the fault went active.

This information can be saved to the computer to be reviewed later or emailed by clicking the Save button.

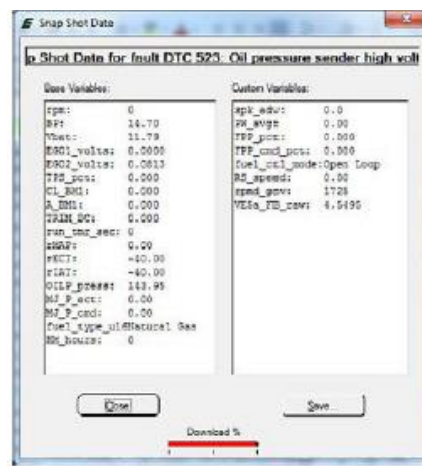

USING THE 4G SOFTWARE - continued

View Flight Data Recorder Data: Pressing this button will pull up a small plot file listing several different parameters and showing how they trended eight seconds before, and 2 seconds after the occurrence of the fault.

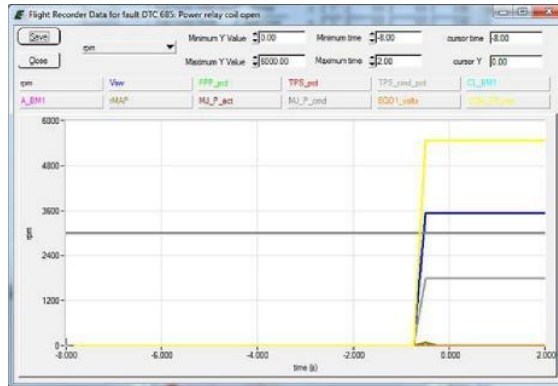

These files can also be saved for later review. Please note that this option is not available for many faults, and the button will be greyed out.

Clicking on any of the faults in the Historic box will give you the option of clearing either the single fault you clicked on or clearing all stored historic faults. Be sure you have collected all the data you need before clearing faults, as there is no way to recover the data once it has been cleared.

Recording a Plot File

Using a Template: To use a previously recorded plot file as a template, click "Plot/Log" on the menu bar, then click "Load Recorder Settings..." Select the plot file to use as a template and press OK. You will notice any parameter that is being plotted will turn green, and the "REC" box at the top of the screen will go from black and white to green with a large red dot in the middle. As long as the record box is colored, the software is recording regardless of whether the plotter window is open.

To see the plot as it's recording, click "Plot/Log" then "Plot Tags" or simply press the P key on the keyboard to open the plot window.

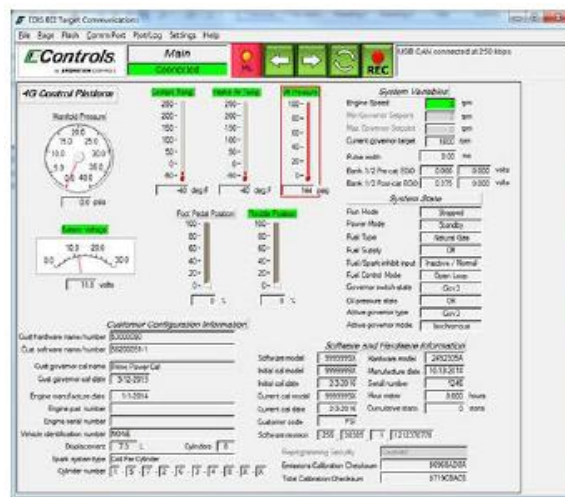

USING THE 4G SOFTWARE - continued

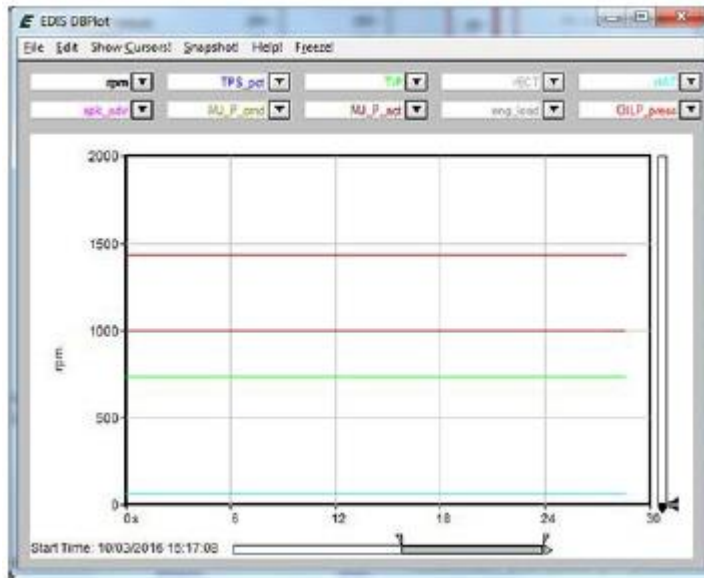

To change the parameters being displayed on the plot, click on the arrow next to the parameter name at the top of the screen. Although only 10 parameters can be displayed on the plot at once, all flagged parameters are being always recorded.

Manually tagging parameters: To manually tag a parameter to be plotted, find the parameter in the 4G software and right-click on it. The parameter will turn green, indicating that it is being recorded.

Making marks: To make a mark in a plot file, press M. A window will open allowing you to type comments on the plot. This is useful to note running characteristics, load changes, ambient conditions, anything that could be useful for someone looking at the plot.

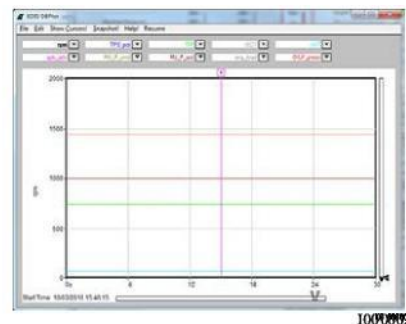
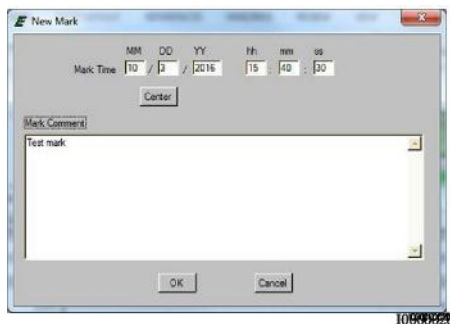

Saving plot files: To save a plot file, click File on the menu bar at the top of the plot window, then click Save... Click the Browse button to choose a location and filename for your plot file, then press OK in the Browse window and Save in the save window. **All unsaved data is erased when the 4G software is closed, so be sure to save all plots before closing the software!!**

USING THE 4G SOFTWARE - continued

Starting a new plot file: If you'd like to delete all previously recorded data and start a new plot file, click the "REC" button at the top of the page. This will stop the recording process and clear out all recorded data. A warning will pop up to verify that you want to clear all data — click Yes to proceed. **Data cannot be restored once recording is stopped so make sure your plot is saved if you want to keep it.**



To restart the recorder, press the "REC" button again, or press P to open up the plot window and begin recording a new plot.



**POWER SOLUTIONS
INTERNATIONAL**

**Power Solutions International, Inc
(PSI)201 Mittel Drive**

**Wood Dale, IL
60191USA**

630-350-9400

